



GENEO - USA CULISANTA ,PRIN RIDICARE, IN PLAN PARALEL

GENEO - SISTEM COMPLET

GENEO
Ferestre



GENEO
Usi



HST GENE0
Usi Culisante



Prezentare generala

Suprafața HDF (finisare High-Definition): este de înaltă calitate, extrem de netedă și durabilă, ușor de curățat
Material **RAU-FIPRO** (rama și canat)

Pachet geam termoizolant -3 foi de sticlă
Pana la 53 mm

Adâncimea constructivă 86mm-5 camere de etansare
Pentru o izolare termică optimă

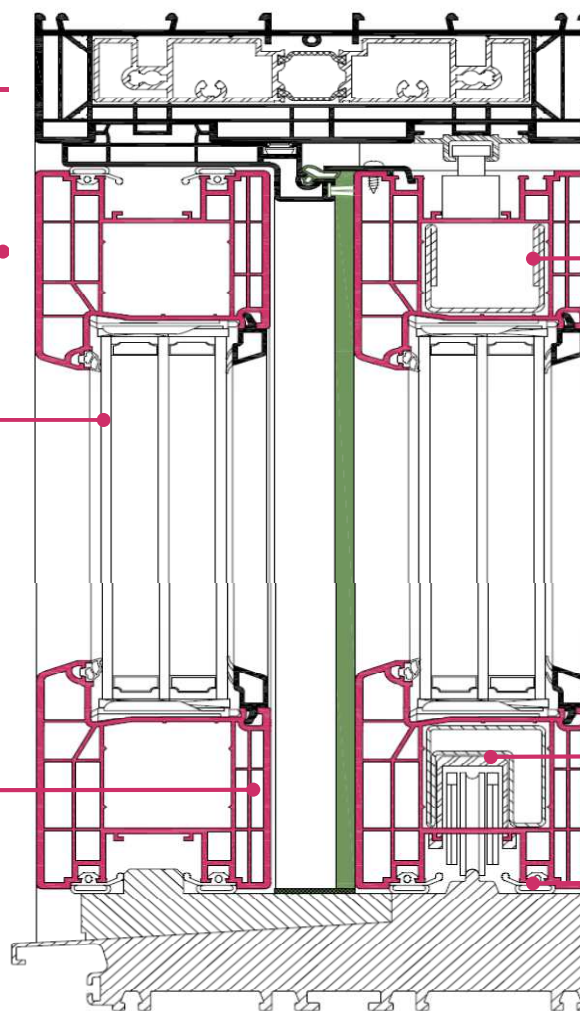

Armături din oțel galvanizat
pentru o stabilitate (statică) și funcționare optimă și îndelungată

Carcasa metalică pt protecția rozelor
și pentru o stabilitate eficientă a canatului

Garnituri de etansare de înaltă calitate
Culoare gri –profile albe
Culoarea neagră –profile color

Adâncimea de 222 mm

Varianta cu prag G-U !

Caracteristici Tehnice

Tipul deschiderii	Culisanta cu ridicare in plan paralel
Material	RAU-FIPRO si RAU-PVC (nu contine cadmiu sau Pb)
Material garnituri	RAU-SR, RAU-PREN (negru, gri)
Adancimea constructiva rama / canat	203 mm / 86 mm
Grosimea maxima geam termoizolant	53 mm
Suprafata vizibila a ramei	63 mm
Suprafata vizibila a canatului	97 mm
Greutatea maxima a canatului	400 kg
Dimensiuni maxime canat (LxH)	Alb - pana la 3000 x 2700 (mm) Color - pana la 2600 x 2600 (mm)
Coeficientul de transfer termic in profil U_f	Pana la 1,3 W/m ² K
Rezistenta la vant	Pana la clasa B3 conform DIN EN 12210
Etanseitatea la apa	Pana la clasa 9A conform DIN EN 12208
Etanseitatea la vant	Clasa 4 conform DIN EN 12207
Functionarea permamnenta	Clasa 2 conform DIN EN 12400
Clasa de izolare fonica	Pana la $R_{w,P} = 42$ dB
Clasa de rezistenta la efracție	Pana la RC2 conform DIN EN 1627
Diversitate de culori	KALEIDO COLOR(folie dekor imitatie lemn sau uni, placare cu Alu

TIPURI DE DESCHIDERE



Schema A, zweiteilig, symmetrisch



Schema C



Schema A, zweiteilig, asymmetrisch



Schema K



Schema A, dreiteilig



Schema G1

LIMITE DIMENSIONALE

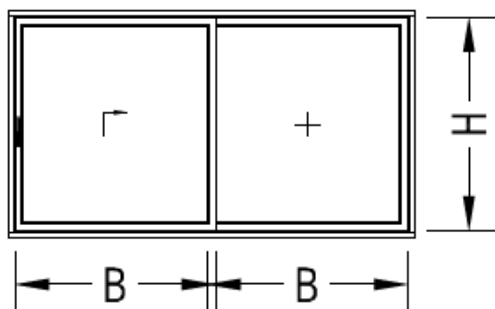

Schema A

Profile albe :

- Lungime element: pana la 10 m
- Inaltime element : pana la 2,80* m
- L(B) x H canat : pana la 3000 x 2700* mm

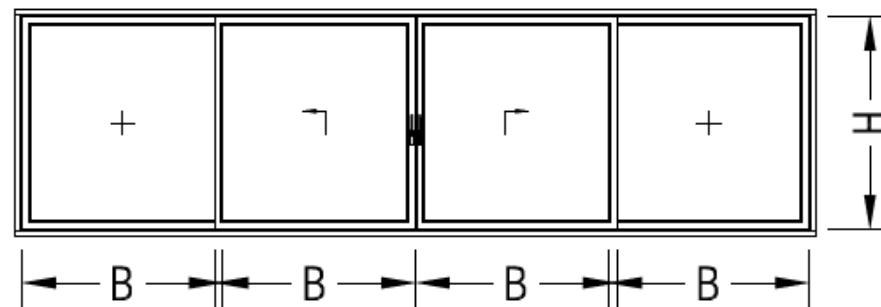

Schema C

Profile color:

- Lungime element: pana la 6.8 m
- Inaltime element: pana la 2,70* m
- L(B) x H canat: pana la 2600 x 2600* mm



Latimea minima a canatului ≥ 900 mm pt canate pana la 300 Kg

Latimea minima a canatului ≥ 1425 mm pt canate de la 301 pana la 400 Kg

* Functie de zona de montaj, respectiv factorii climatici (expunerea la actiunea vantului etc.)

PROFILE PRINCIPALE

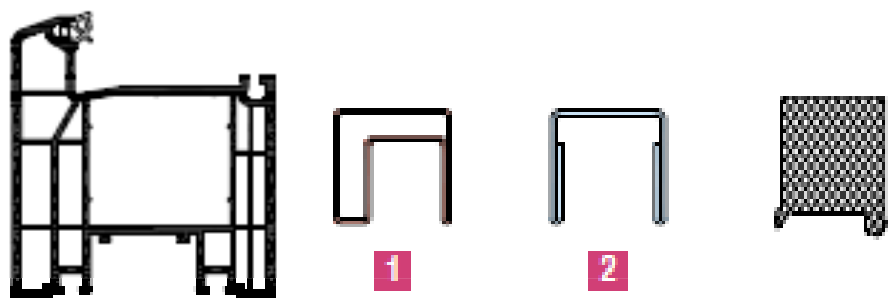

Canat 97 + armaturi 1 si 2 (+ optional thermomodul pt canatul fixaturile care se fixeaza in rama !)

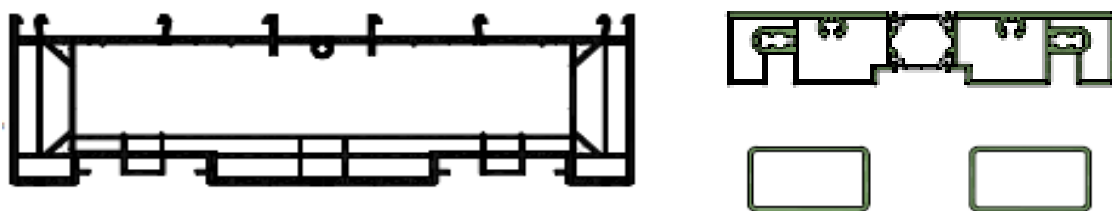

Rama +Armatura Alu sau rectangulara din otel



Profil inchidere median + armatura

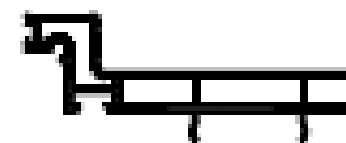

Profil clipsare rama exterior



Profil acoperire canat



Profil acoperire rama



Profil opritor /stulp

PRODUCTIE OPTIMIZATA

Garniturile de etansare continue, cu colturile vulcanizate, protejeaza fata de curentii de aer, praf, apa si pierderi de caldura.

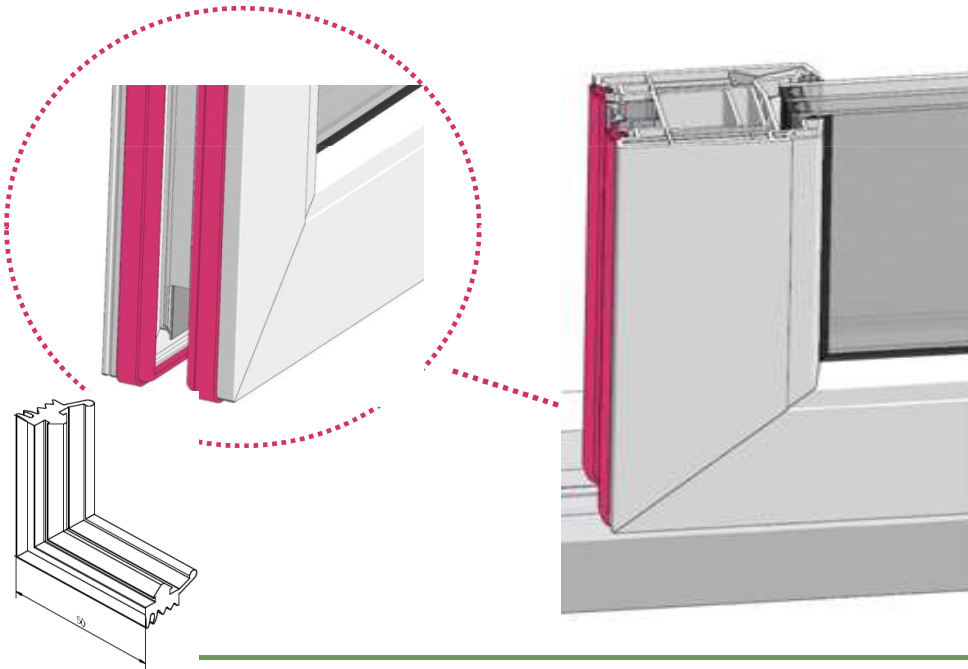

Armatura din aluminiu prevazuta cu bariera termica, în combinatie cu rama multicamerala , garanteaza proprietati termoizolante exceptionale.

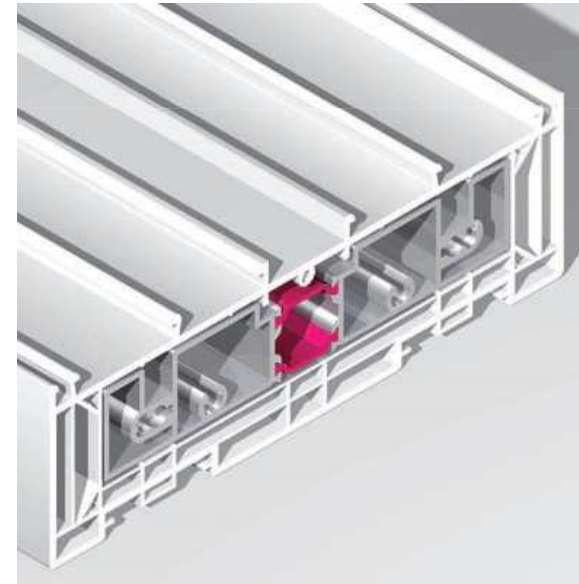

PRODUCTIE OPTIMIZATA

Fara frezari suplimentare - Exista capace de capat profilate pentru sina de sus si calea de rulare!

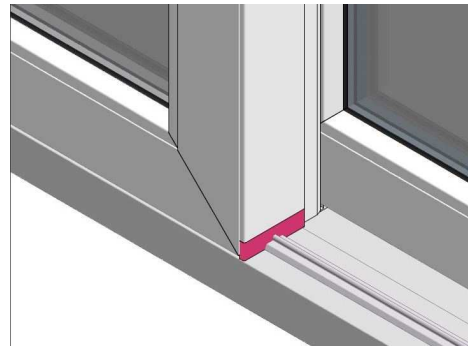
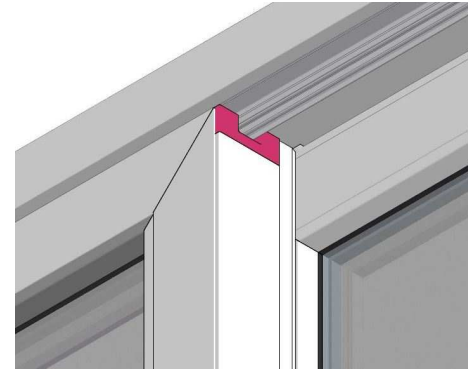
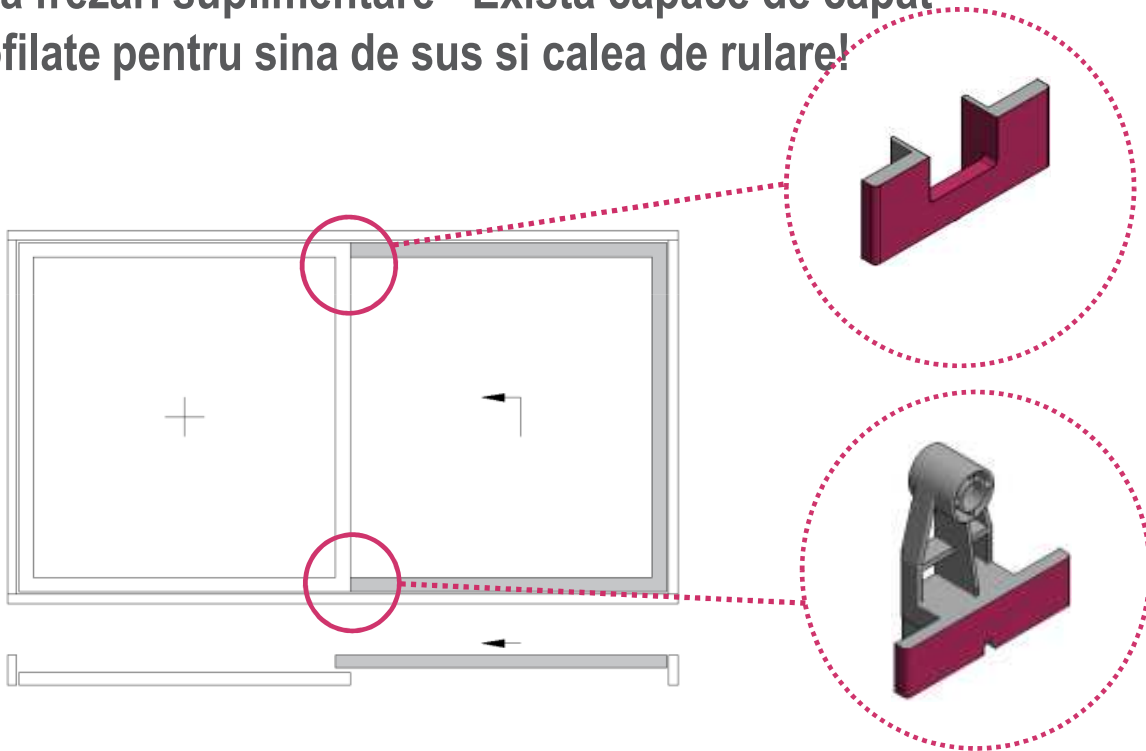

CONFECTIONARE SIGURA

Profilul rama

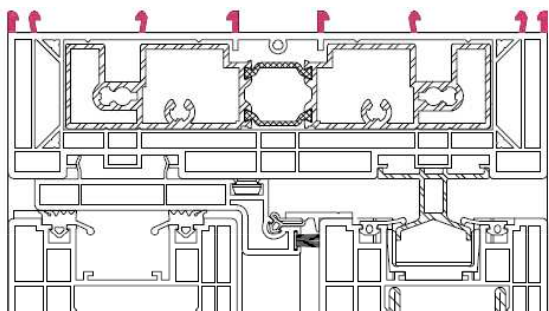

Nervurile ramei permit clipsarea diverselor profile auxiliare si din seria de 86mm.

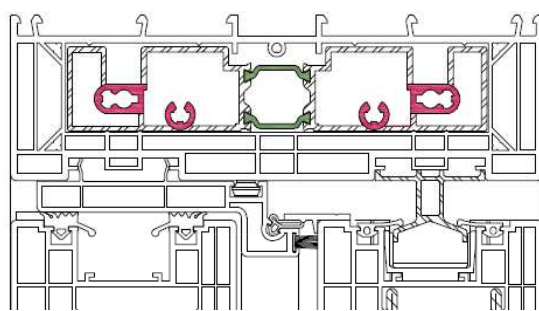

Armatura din Alu (cu rupere termica) este prevazuta cu canale pt. insurubare integrate asigura o conexiune rapida si stabila intre rame si pragul de aluminiu

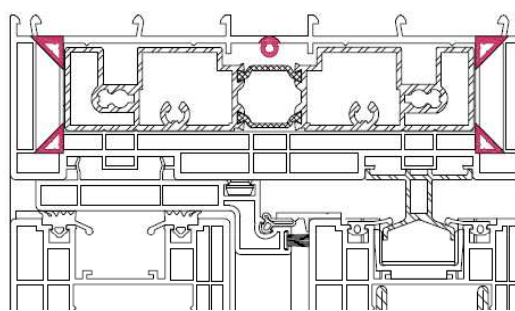

Rama este prevazuta cu canale de insurubare suplimentare asigurand conexiuni sigure si stabile intre rame si prag (varianta cu armatura din otel)

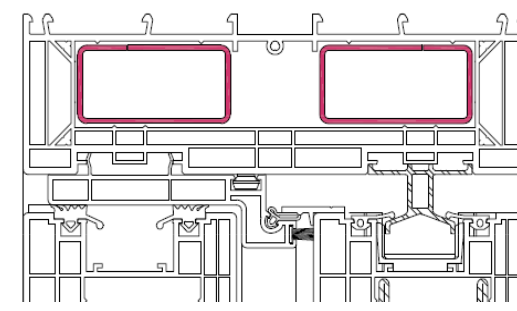

Alternativ rama poate fi armata si cu armaturi din otel

CONFECTIONARE SIGURA

Profilul canat

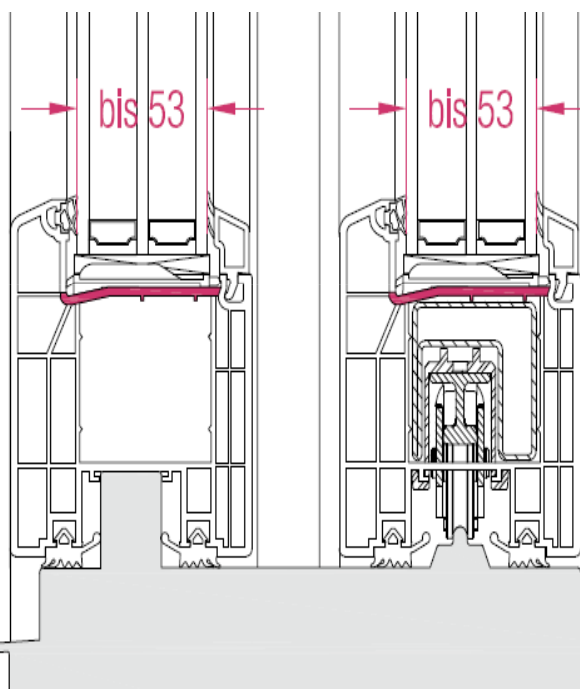

Datorita adancimii constructive, respectiv a faltului generos, se pot monta geamuri/panouri termoizolante cu grosimi de pana la 53mm

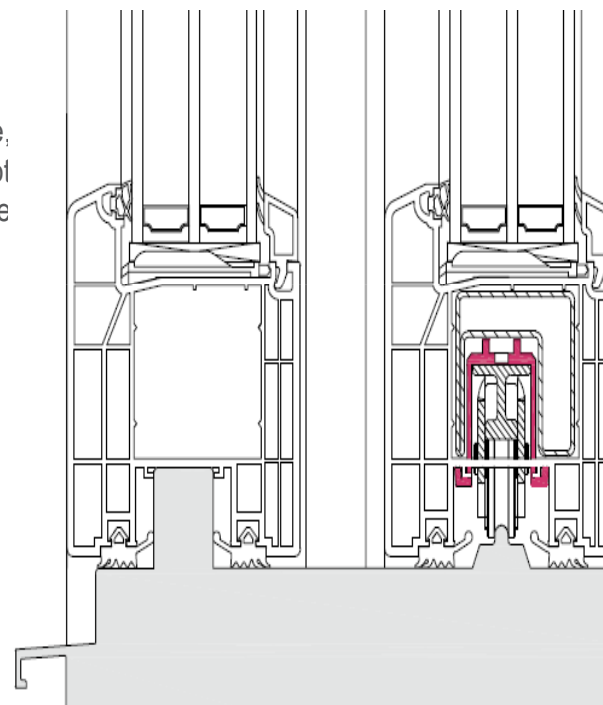

Carcasele de protectie din otel ale rolor, asigura o functionare sigura a mecanismului precum si o stabilitate a canatului datorita contactului direct cu armatura.

Argumente client: Beneficii & Oportunitati

KALEIDO COLOR

- Varietatea de culori Rehau
- Caserare (folii dekor imitatie lemn/uni) sau placare, la exterior, cu Alu



Profile Caserate -Corp de baza

Varianta -maro sau caramel

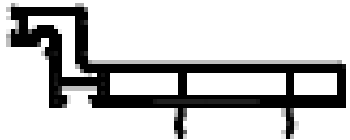
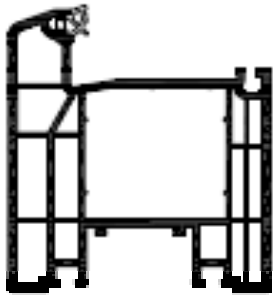

Numai in varianta alb



Placarea cu Aluminiu

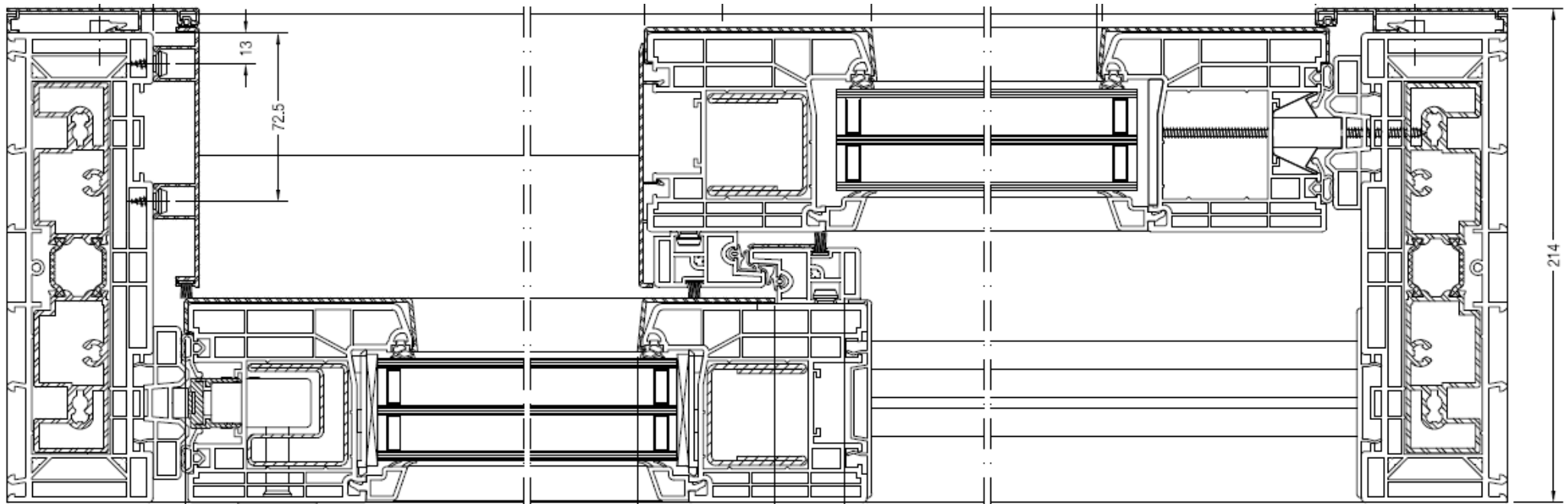

VARIAT SI ECONOMIC

- Completeaza perfect sistemul de ferestre si usi Geneo
- Lungimi ale elementelor pana la 10m si 2.8m inaltime (inclusiv pragul)
- Productie sigura si eficienta
- Eficienta energetica
- Diversitate de culori prin REHAU KALEIDO COLOR:
 - Folii dekor imitatie lemn sau uni, aplicate pe profile albe sau corp de baza maro sau caramel(exceptie profilul rama si profilul de inchidere median care sunt numai in var.alb)
 - Placarea ,la exterior ,cu profile din Aluminiu: